























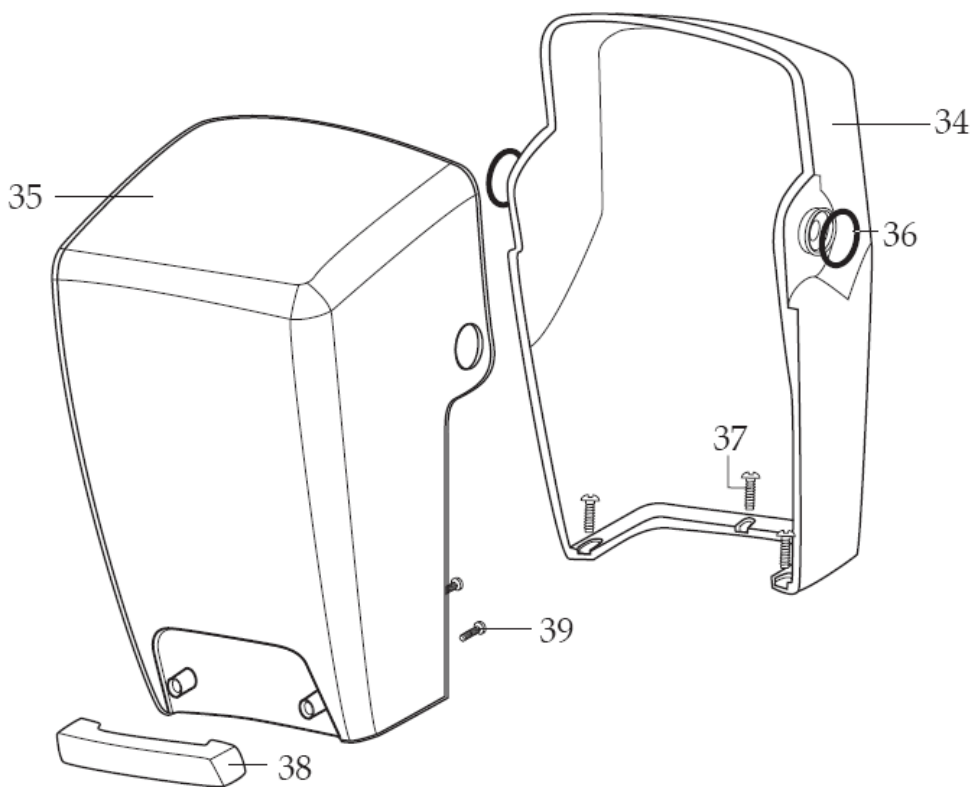

Machine	Explode	Code	Description
Waring Xtreme Hi-Power Blender		DM876	WARING STACKING MX JAR
Waring Xtreme Hi-Power Blender		AC900	STACKABLE POLYCARBONATE CONTAINER WITH LID - 48OZ
Waring Xtreme Hi-Power Blender	1	See	JAR LID COVER
Waring Xtreme Hi-Power Blender	2		JAR LID
Waring Xtreme Hi-Power Blender	3	DM876	JAR ONLY / 64 OZ. STACKABLE JAR WITH BLENDING ASSY. / 64 OZ. STACKABLE
Waring Xtreme Hi-Power Blender	4		BLADE ASSY.
Waring Xtreme Hi-Power Blender	5		BEARING HOLDER O RING
Waring Xtreme Hi-Power Blender	6		NUT GASKET
Waring Xtreme Hi-Power Blender	7		BEARING HOLDER NUT
Waring Xtreme Hi-Power Blender	8	AC930	DRIVE CLUTCH
Waring Xtreme Hi-Power Blender	9		JAR PAD
Waring Xtreme Hi-Power Blender	10		JAR PAD / SOUND ENCLOSURE
Waring Xtreme Hi-Power Blender	11	AC931	MOTOR
Waring Xtreme Hi-Power Blender	12	AC932	DAMPENING PLATE GASKET
Waring Xtreme Hi-Power Blender	13		TOP HOUSING/ BLACK
Waring Xtreme Hi-Power Blender	14		MOTOR FOAM 2 REQ.'D
Waring Xtreme Hi-Power Blender	15		DAMPENING PLATE BUSHING 4 REQ.'D
Waring Xtreme Hi-Power Blender	16		DAMPENING PLATE SLEEVE 4 REQ.'D
Waring Xtreme Hi-Power Blender	17		WASHER 2 REQ.'D
Waring Xtreme Hi-Power Blender	18		SCREW 4 REQ.'D
Waring Xtreme Hi-Power Blender	19	WA355	CONTROL PANEL
Waring Xtreme Hi-Power Blender	20		HOUSING FOAM BAFFLE / REAR
Waring Xtreme Hi-Power Blender	21		HOUSING FOAM BAFFLE / FRONT
Waring Xtreme Hi-Power Blender	22		MOTOR HOUSING
Waring Xtreme Hi-Power Blender	23		BOTTOM HOUSING FOAM BAFFLE
Waring Xtreme Hi-Power Blender	24		WASHER 3 REQ.'D
Waring Xtreme Hi-Power Blender	25		FOAM BAFFLE
Waring Xtreme Hi-Power Blender	26		CABLE TIE 3 REQ.'D
Waring Xtreme Hi-Power Blender	27	AC934	CORD SET
Waring Xtreme Hi-Power Blender	28		STRAIN RELIEF
Waring Xtreme Hi-Power Blender	29		BOTTOM HOUSING / BLACK
Waring Xtreme Hi-Power Blender	30	AC938	SCREW 4 REQ.'D
Waring Xtreme Hi-Power Blender	31		CORNER POST 4 REQ. 'D
Waring Xtreme Hi-Power Blender	32		SCREW 4 REQ.'D
Waring Xtreme Hi-Power Blender	503351		MX COUPLING WRENCH (OPTIONAL)
Waring Xtreme Hi-Power Blender	503392		SPANNER WRENCH (OPTIONAL)



Machine	Explode	Code	Description
Waring Xtreme Hi-Power Blender	34	☎	INNER ENCLOSURE / 64 OZ.
Waring Xtreme Hi-Power Blender	35	☎	OUTER ENCLOSURE / 64 OZ.
Waring Xtreme Hi-Power Blender	36	☎	O RING 2 REQ.'D
Waring Xtreme Hi-Power Blender	37	AC937	SCREW 2 REQ.'D
Waring Xtreme Hi-Power Blender	38	AC939	SOUND ENCLOSURE HANDLE
Waring Xtreme Hi-Power Blender	39	AC938	SCREW 2 REQ.'D